

PUMP SINGLE SPEED M2 (19)

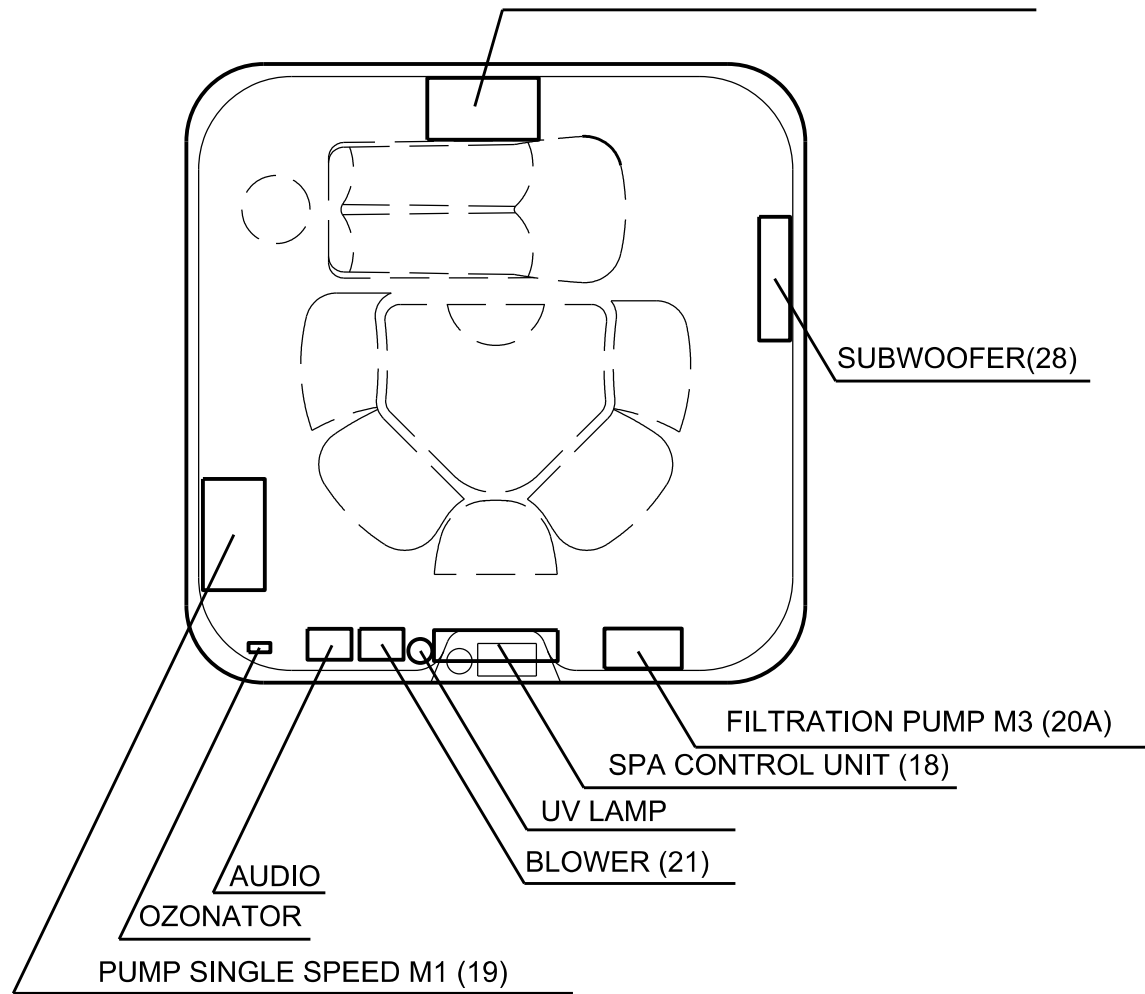

B-B

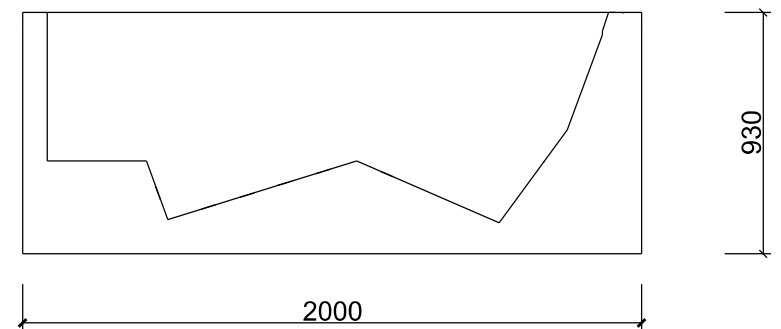

Hight: 930mm

Pump	connected	SUM
M1:	24 + ozonator + waterfall	26
M2:	25	25
M3:	FILTRATION	

Water Jets	49
Air Jets	10
Lounge seats	1
Sitting seats	4

COMMENT: AUDIO, SUBWOOFER IS NON STANDARD EQUIPMENT FOR HC MODELS

HANSCRAFT[®]
european spa producer

2000x2000	rev.08	NOV. 2021
HC1	AUTHOR: ING. JAN. F. VORISEK	DWG No: 1

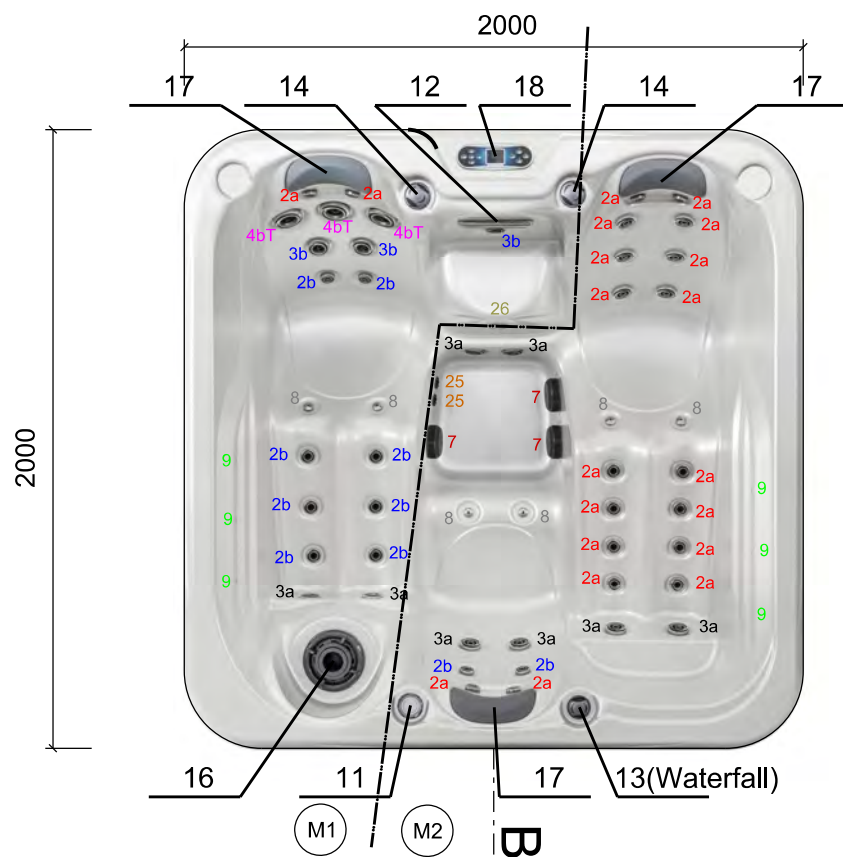

B-B

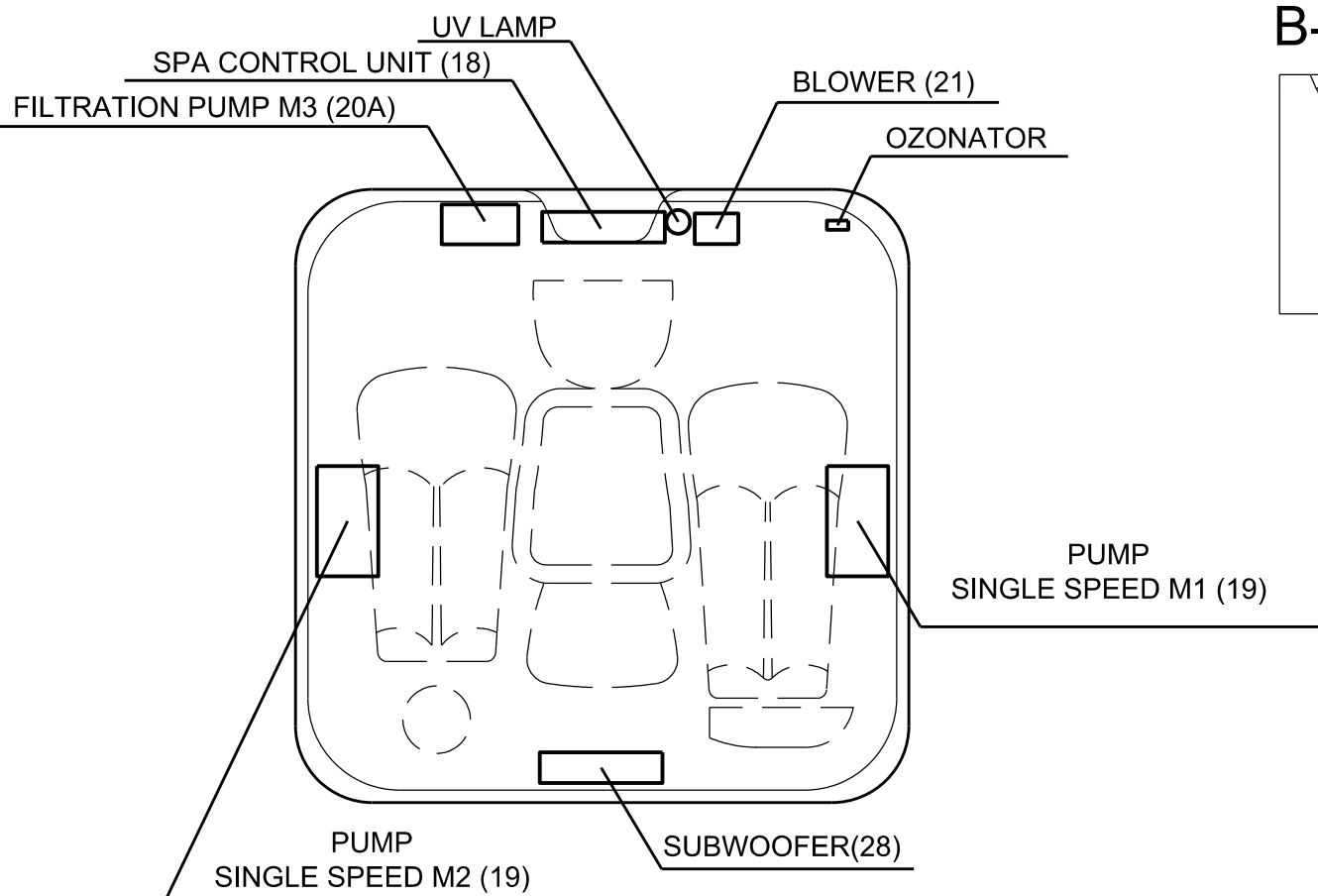
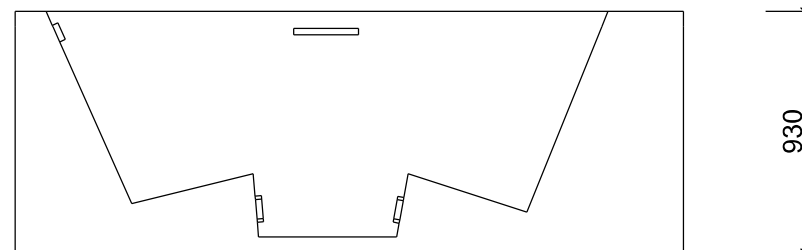

Hight: 930mm

Pump	connected	SUM
M1:	18 + ozonator + waterfall	20
M2:	26	26
M3:	FILTRATION	

Water Jets	44
Air Jets	6
Lounge seats	2
Sitting seats	2

COMMENT: AUDIO, SUBWOOFER IS NON STANDARD EQUIPMENT FOR HC MODELS

HANSCRAFT[®]
european spa producer

2000x2000	rev.08	NOV. 2021
HC2	AUTHOR: ING. JAN. F. VORISEK	DWG No: 1

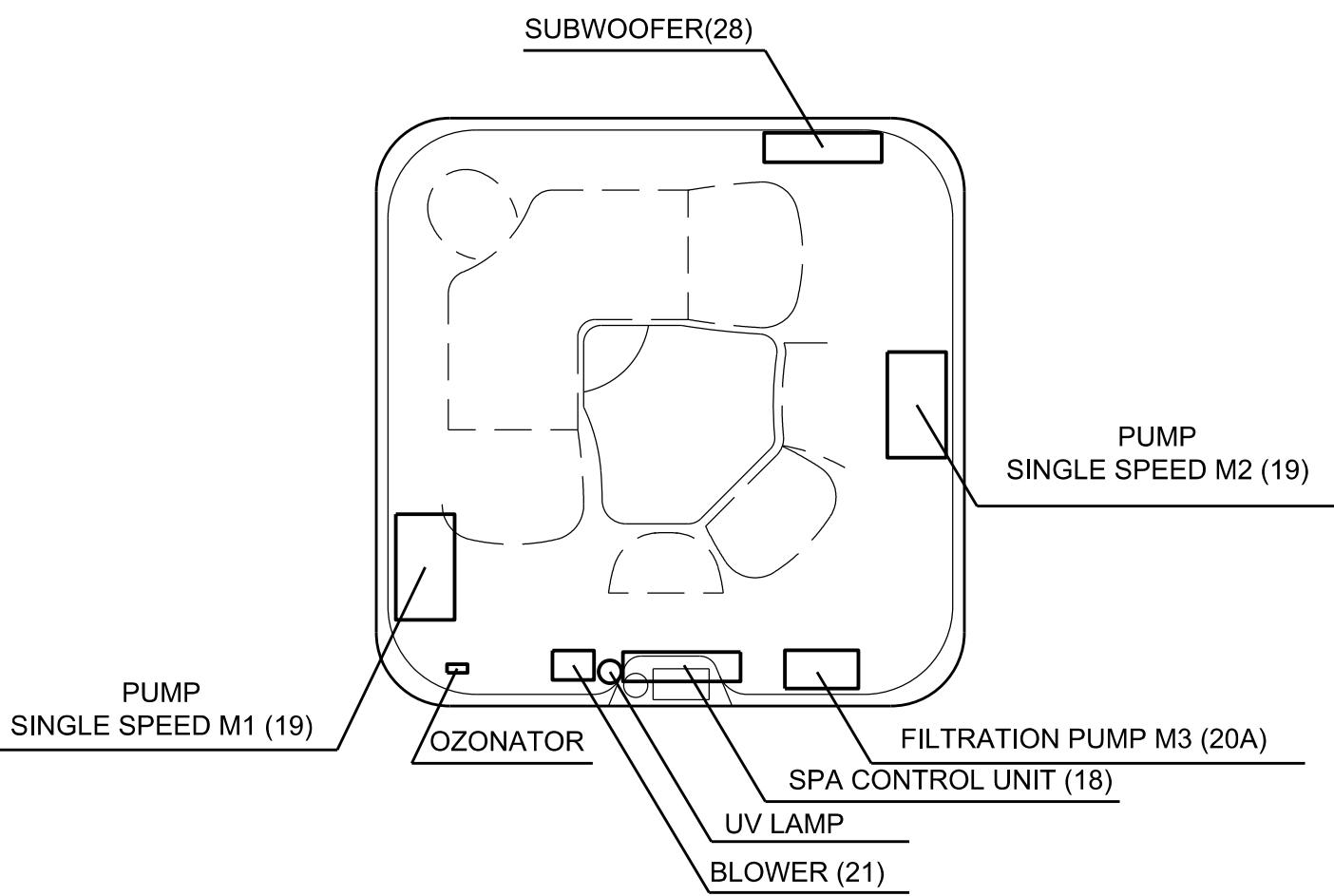
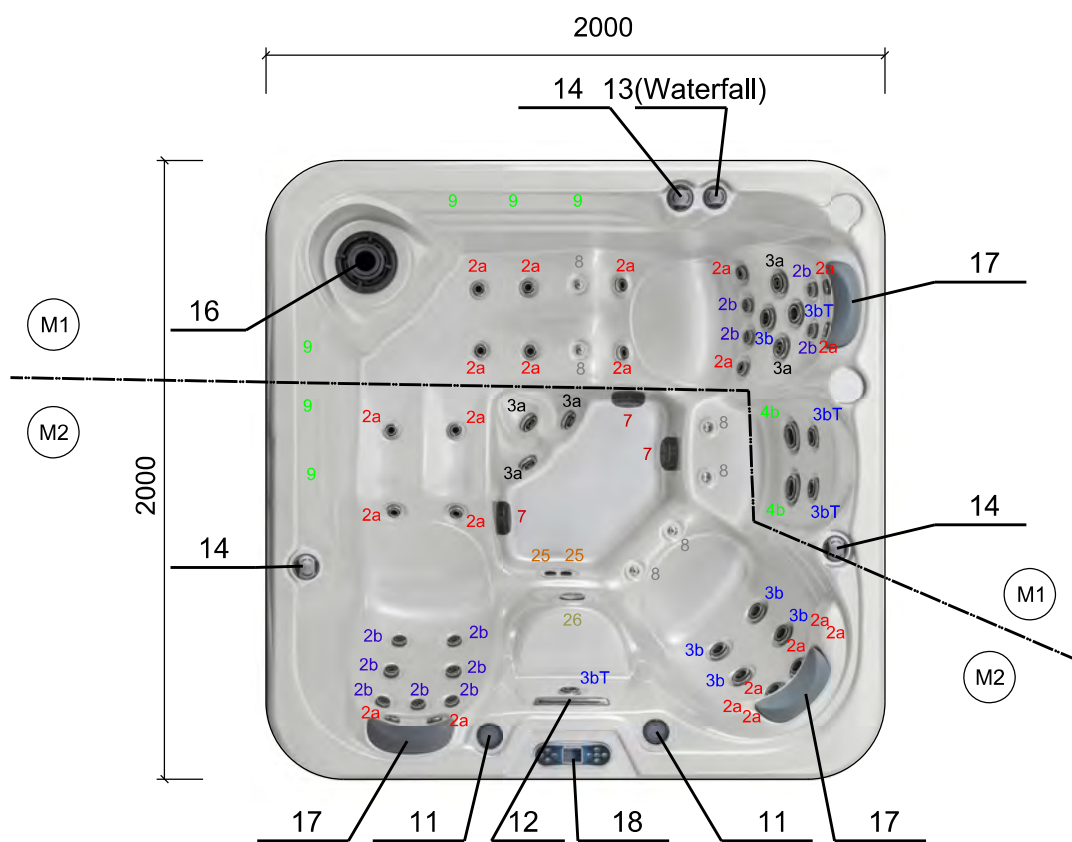

Hight: 930mm

Pump	connected	SUM
M1:	23 + ozonator + waterfall	25
M2:	26	26
M3:	FILTRATION	

Water Jets	49
Air Jets	6
Lounge seats	2
Sitting seats	3

COMMENT: AUDIO, SUBWOOFER IS NON STANDARD EQUIPMENT FOR HC MODELS

HANSCRAFT
european spa producer

2000x2000	rev.08	NOV. 2021
HC3	AUTHOR: ING. JAN. F. VORISEK	DWG No: 1

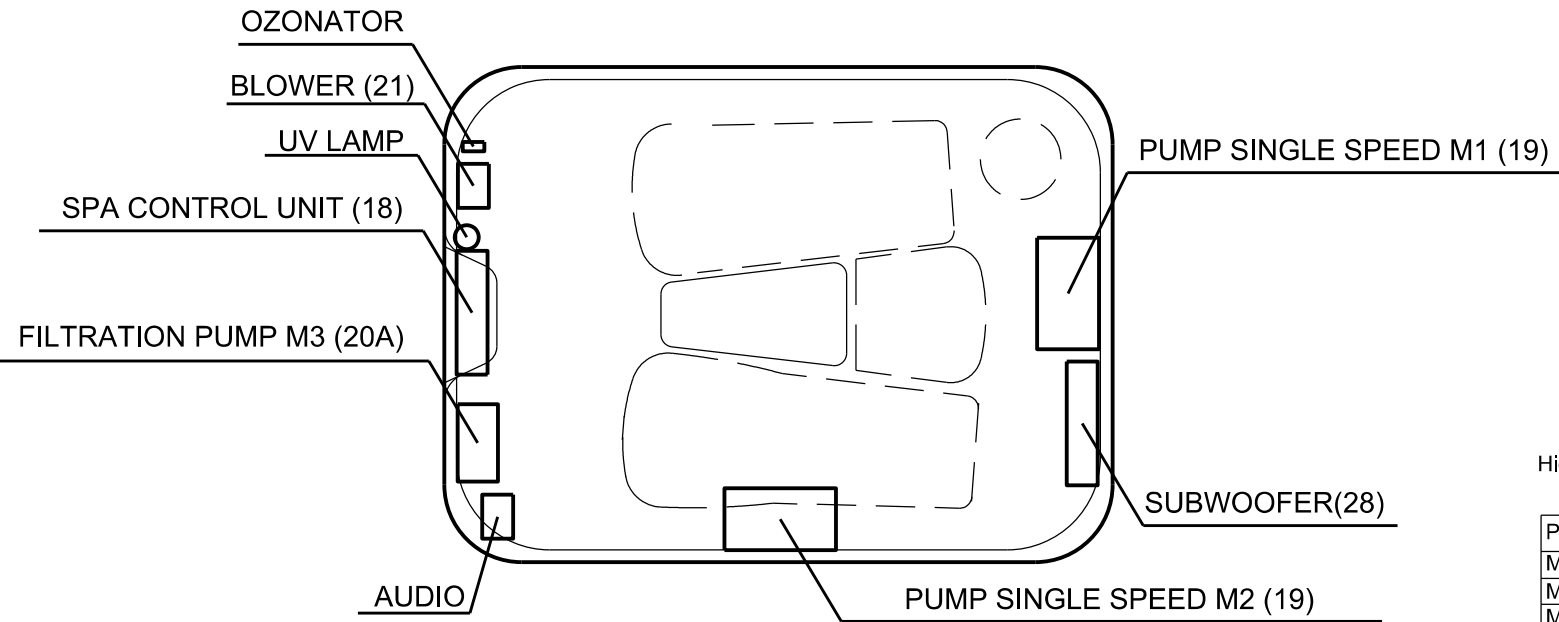
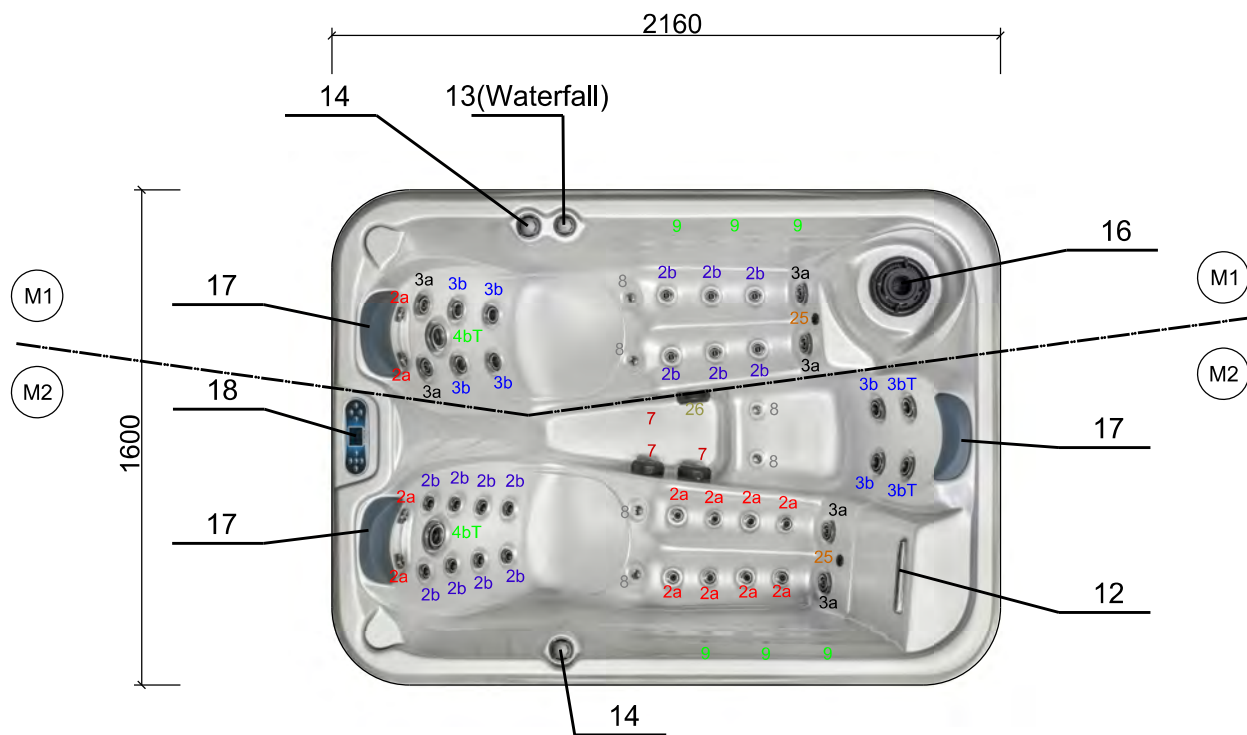

Hight: 930mm

Pump	connected	SUM
M1:	17 + ozonator + waterfall	19
M2:	25	25
M3:	FILTRATION	

Water Jets	42
Air Jets	6
Lounge seats	2
Sitting seats	1

COMMENT: AUDIO, SUBWOOFER IS NON STANDARD EQUIPMENT FOR HC MODELS

HANSCRAFT[®]
european spa producer

2160x1600

rev.08

NOV.
2021

HC4

AUTHOR:
ING. JAN. F. VORISEK

DWG No: **1**

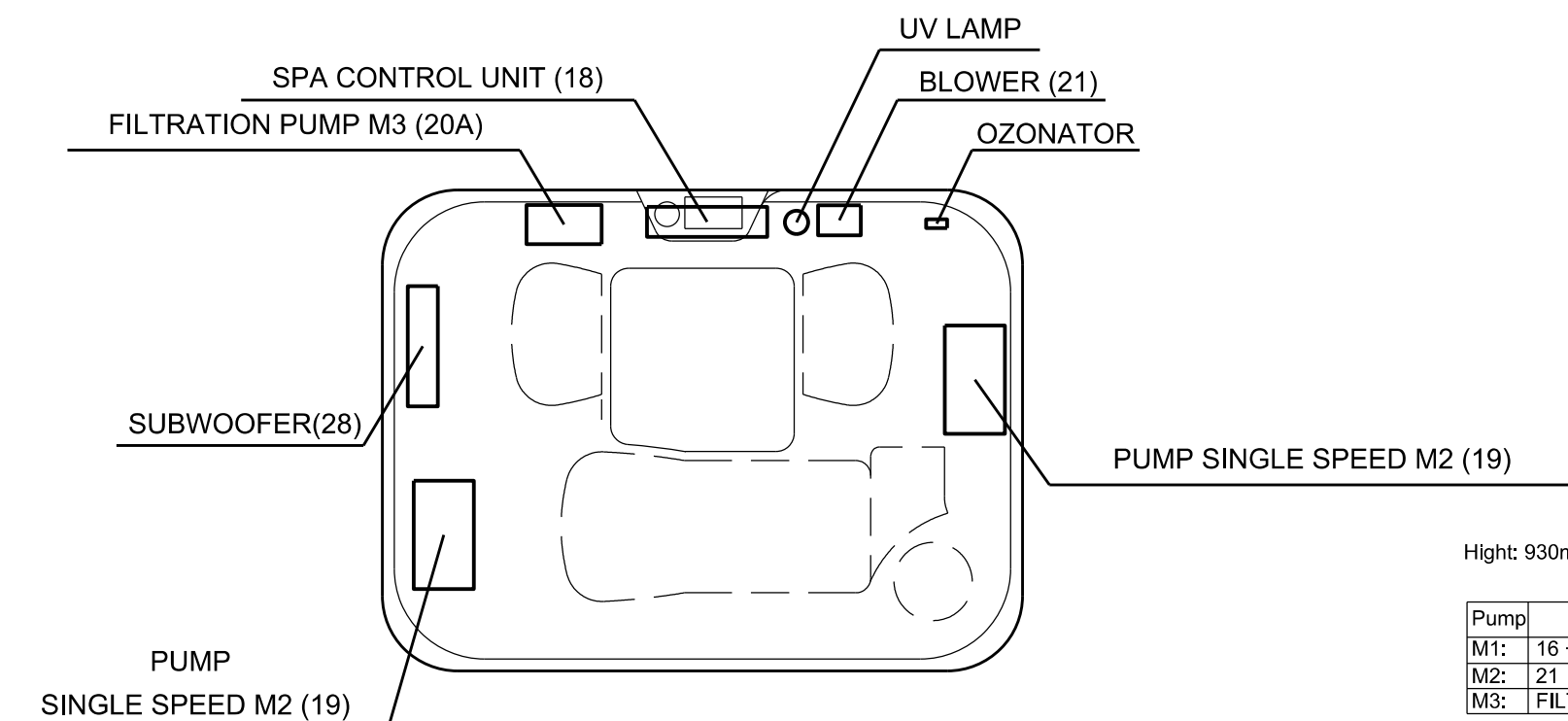
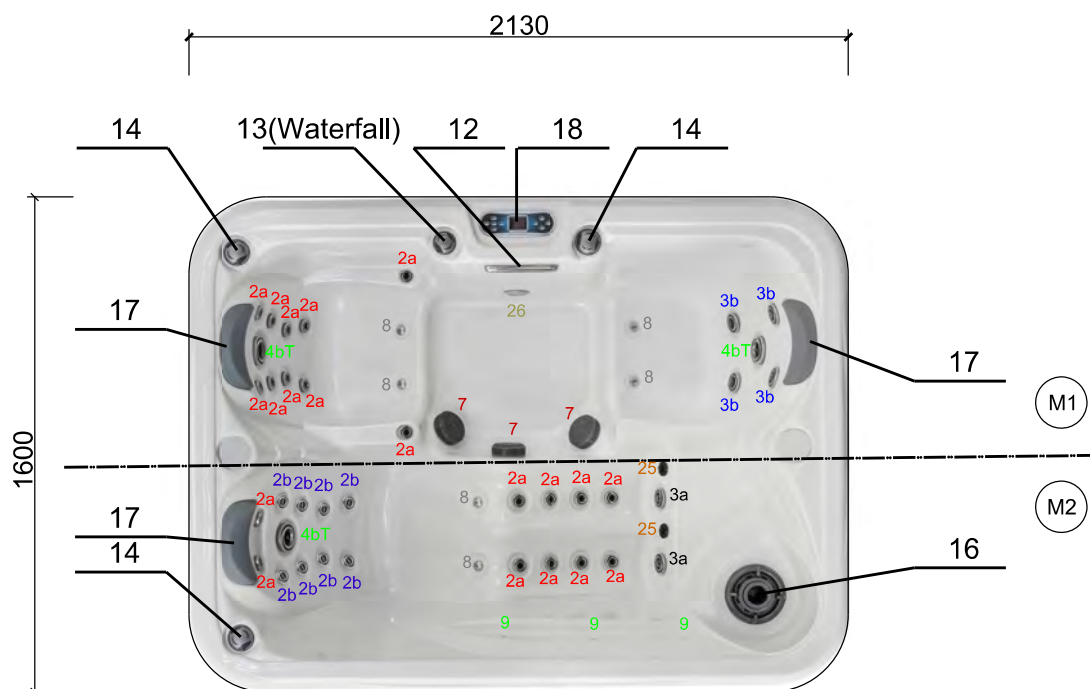

Hight: 930mm

Pump	connected	SUM
M1:	16 + ozonator + waterfall	18
M2:	21	21
M3:	FILTRATION	

Water Jets	37
Air Jets	6
Lounge seats	1
Sitting seats	2

COMMENT: AUDIO, SUBWOOFER IS NON STANDARD EQUIPMENT FOR HC MODELS



2130x1600	rev.08	NOV. 2021
HC5	AUTHOR: ING. JAN. F. VORISEK	DWG No: 1

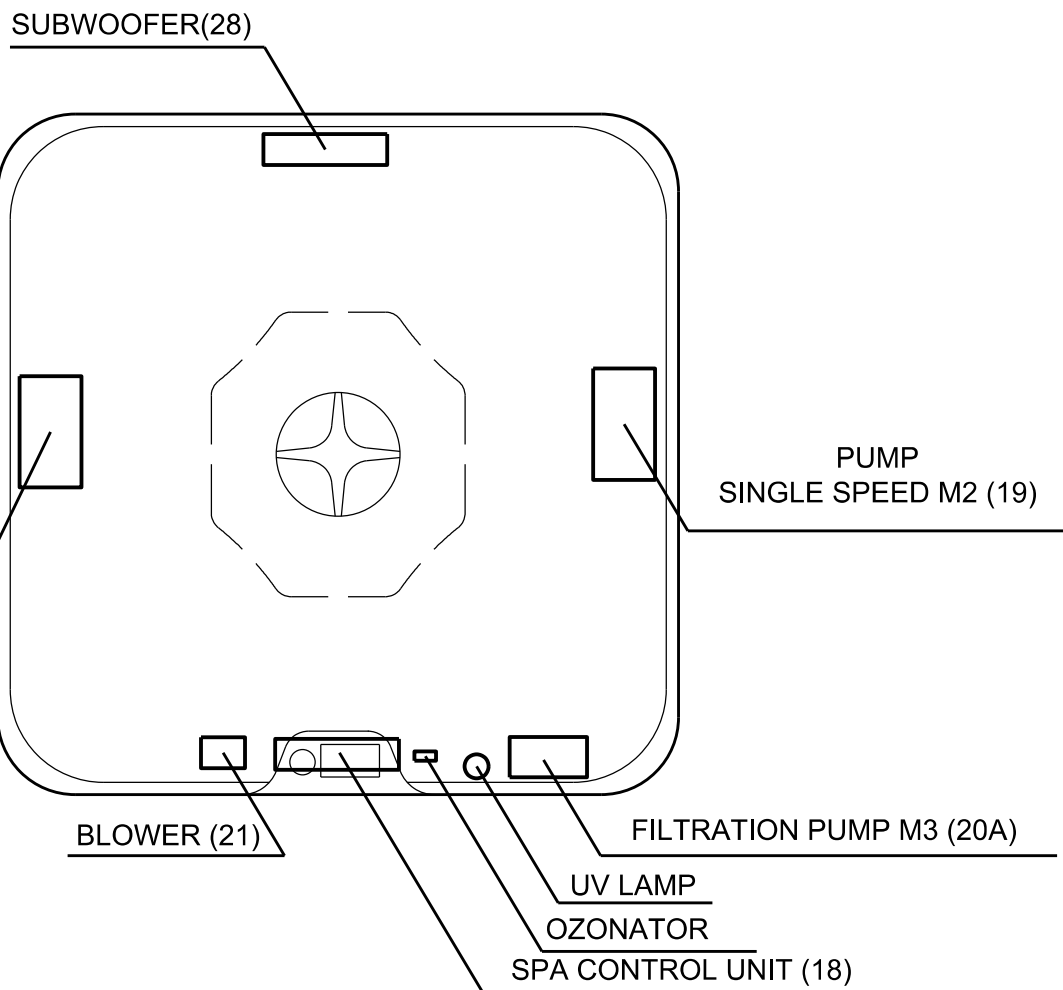
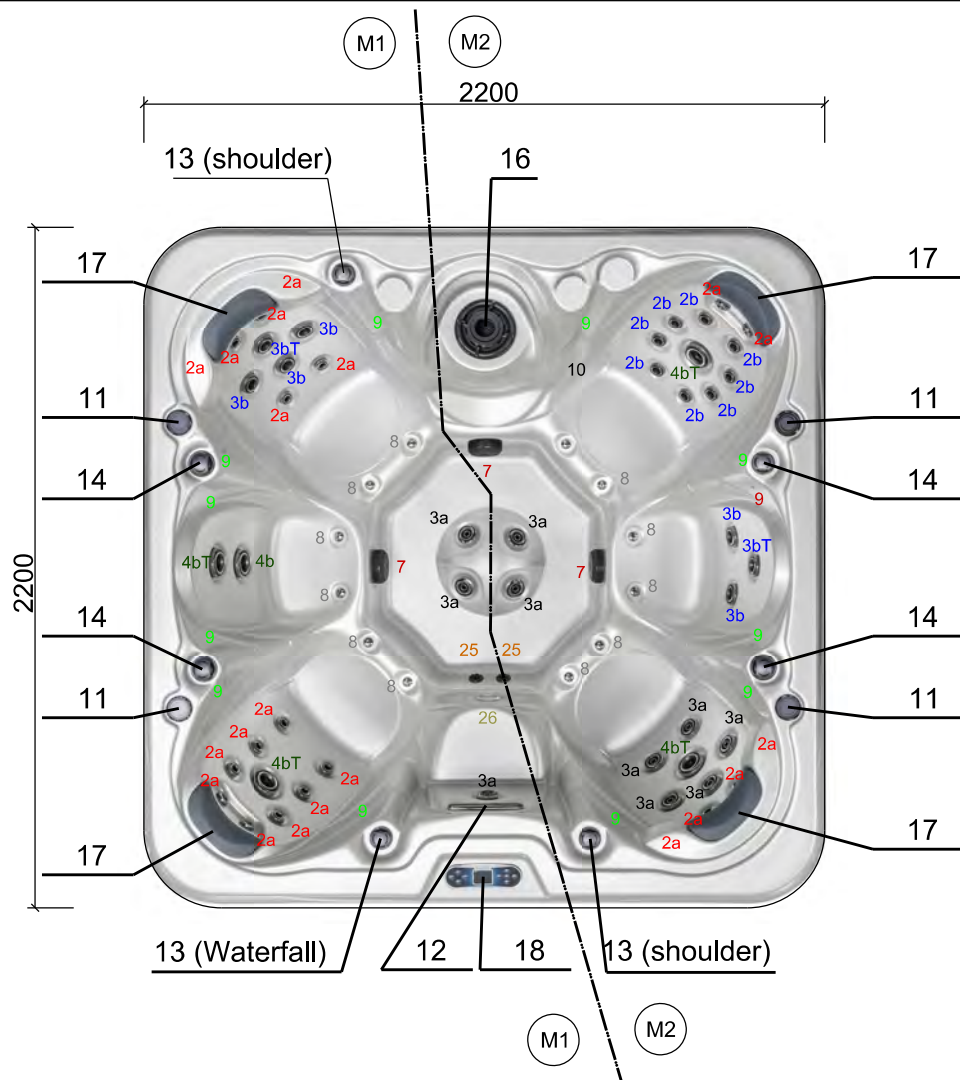

Hight: 930mm

Pump	connected	SUM
M1:	24 + ozonator + waterfall	26
M2:	26	26
M3:	FILTRATION	

Water Jets	50
Air Jets	12
Lounge seats	0
Sitting seats	7

COMMENT: AUDIO, SUBWOOFER IS NON STANDARD EQUIPMENT FOR HC MODELS

HANSCRAFT
european spa producer

2200x2200	rev.08	NOV. 2021
HC6	AUTHOR: ING. JAN. F. VORISEK	DWG No: 1

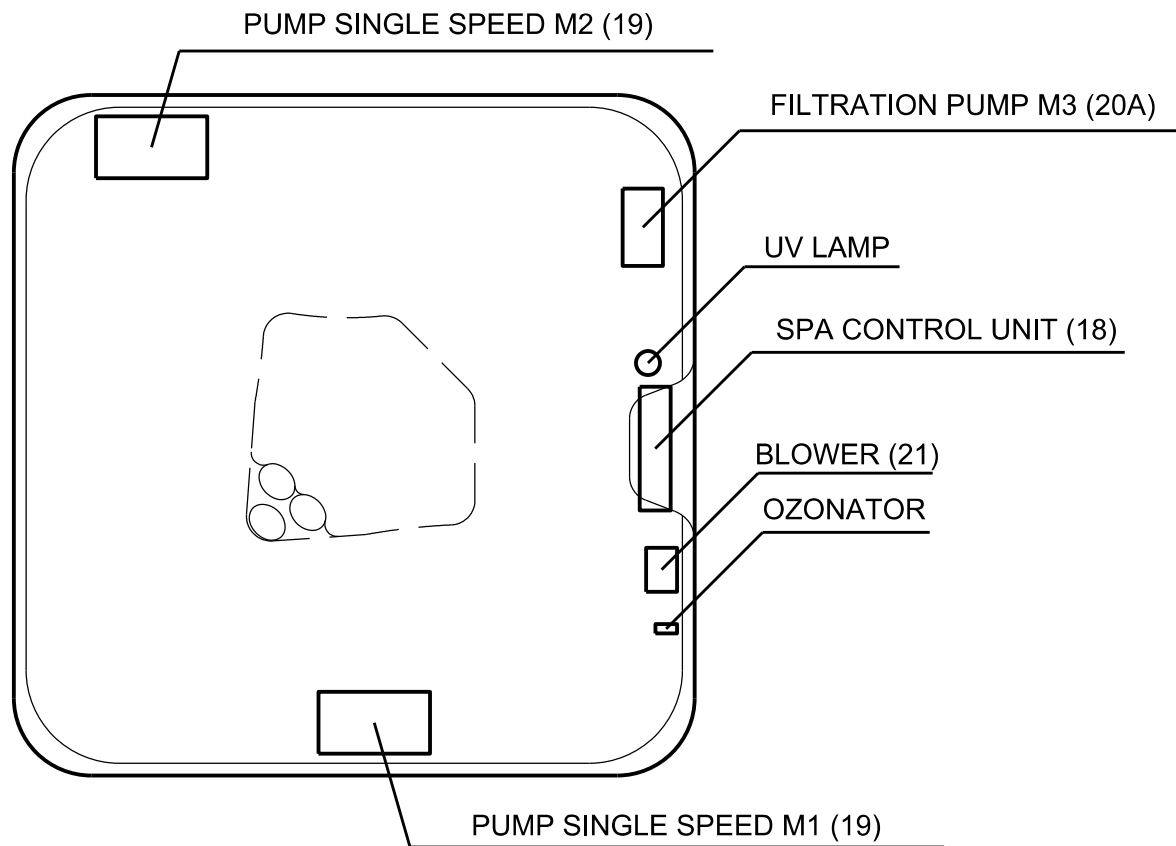
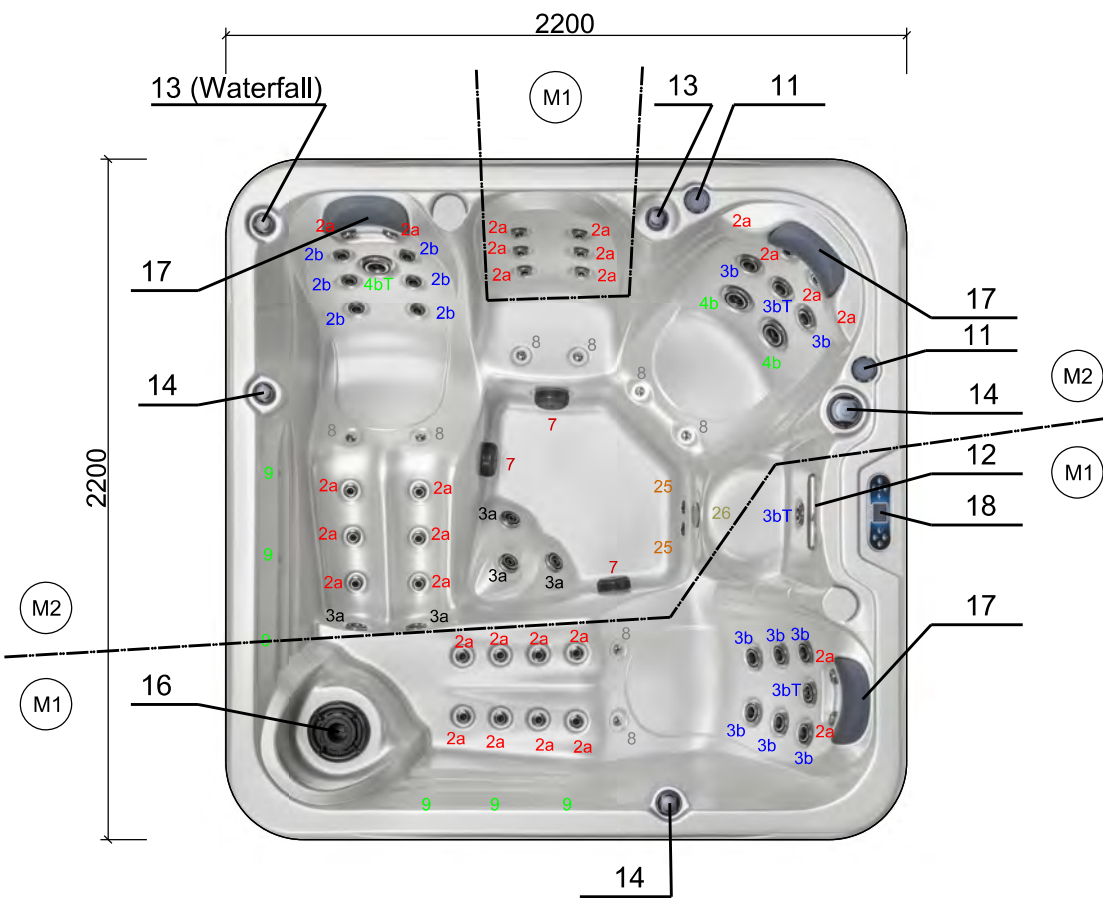

Hight: 930mm

Pump	connected	SUM
M1:	24 + ozonator + waterfall	26
M2:	29	29
M3:	FILTRATION	

Water Jets	53
Air Jets	8
Lounge seats	2
Sitting seats	3

COMMENT: AUDIO, SUBWOOFER IS NON STANDARD EQUIPMENT FOR HC MODELS

HANSCRAFT[®]
 european spa producer

2200x2200	rev.08	NOV. 2021
HC7	AUTHOR: ING. JAN. F. VORISEK	DWG No: 1

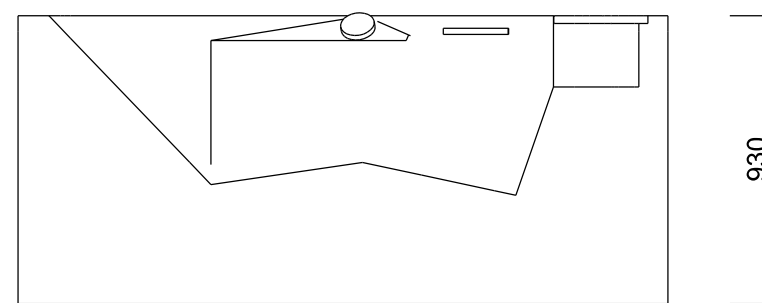
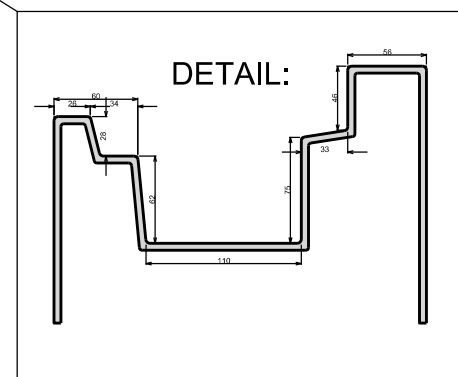
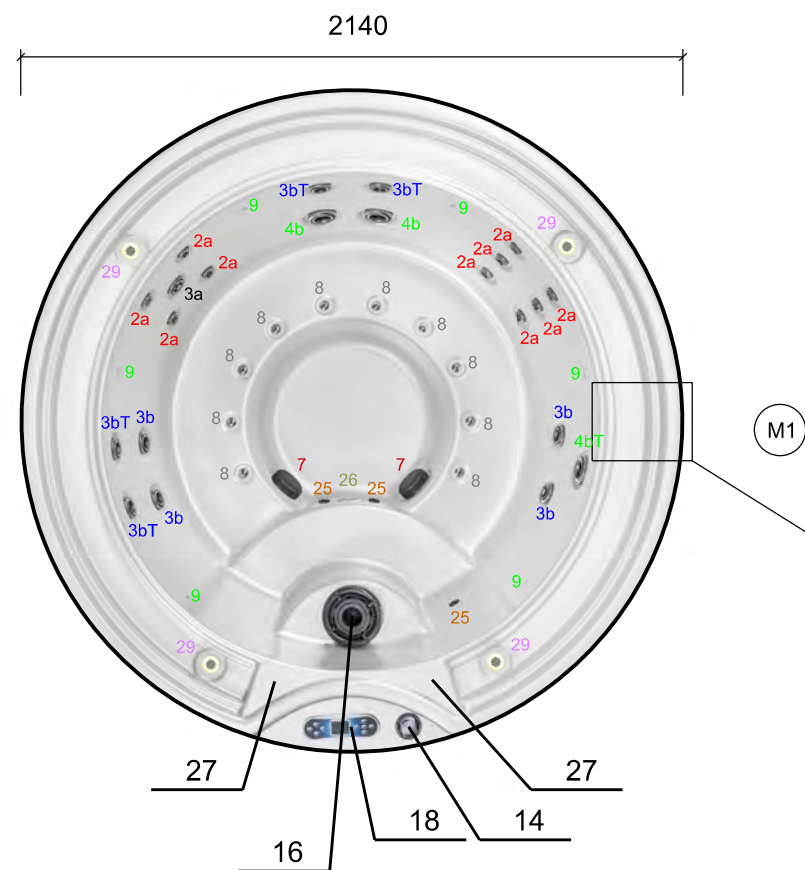

Hight: 930mm

Pump	connected	SUM
M1:	22	22
M2:	FILTRATION	

Water Jets	22
Air Jets	10
Lounge seats	0
Sitting seats	5

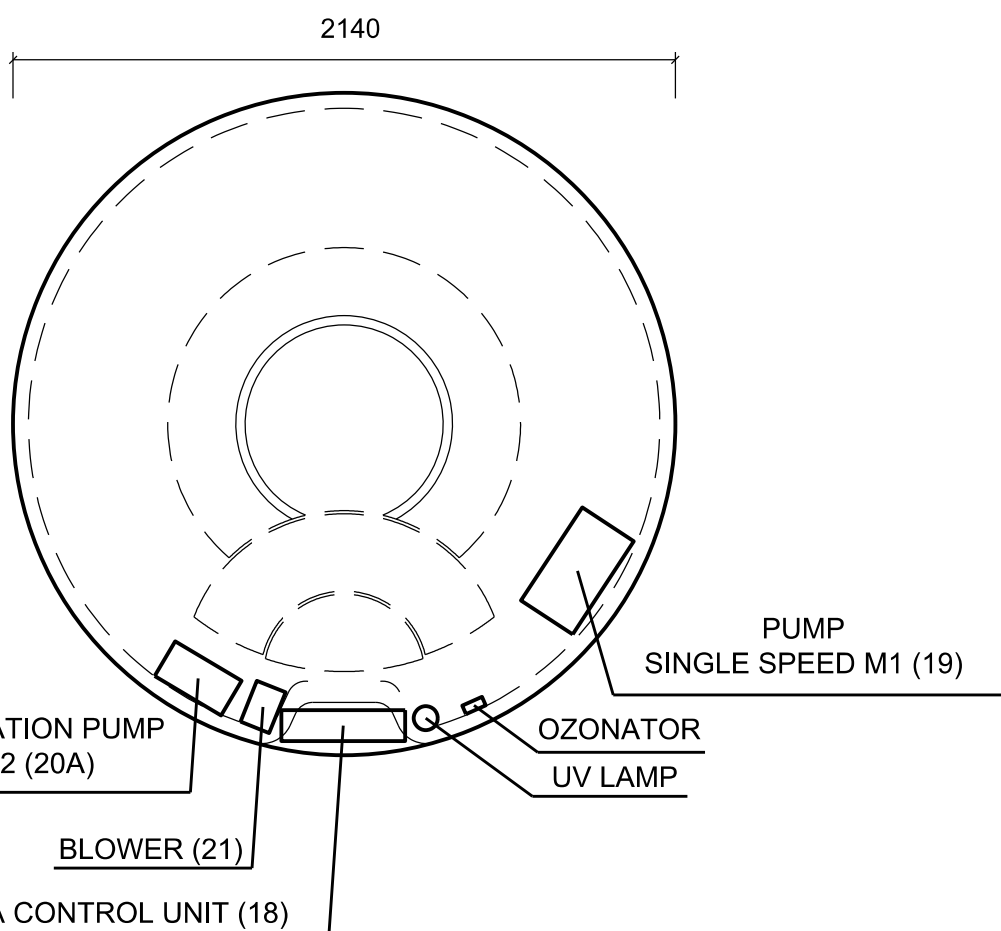

COMMENT: AUDIO, SUBWOOFER IS NON STANDARD EQUIPMENT FOR HC MODELS



Ø2140	rev.08	NOV. 2021
HC8	AUTHOR: ING. JAN. F. VORISEK	DWG No: 1